

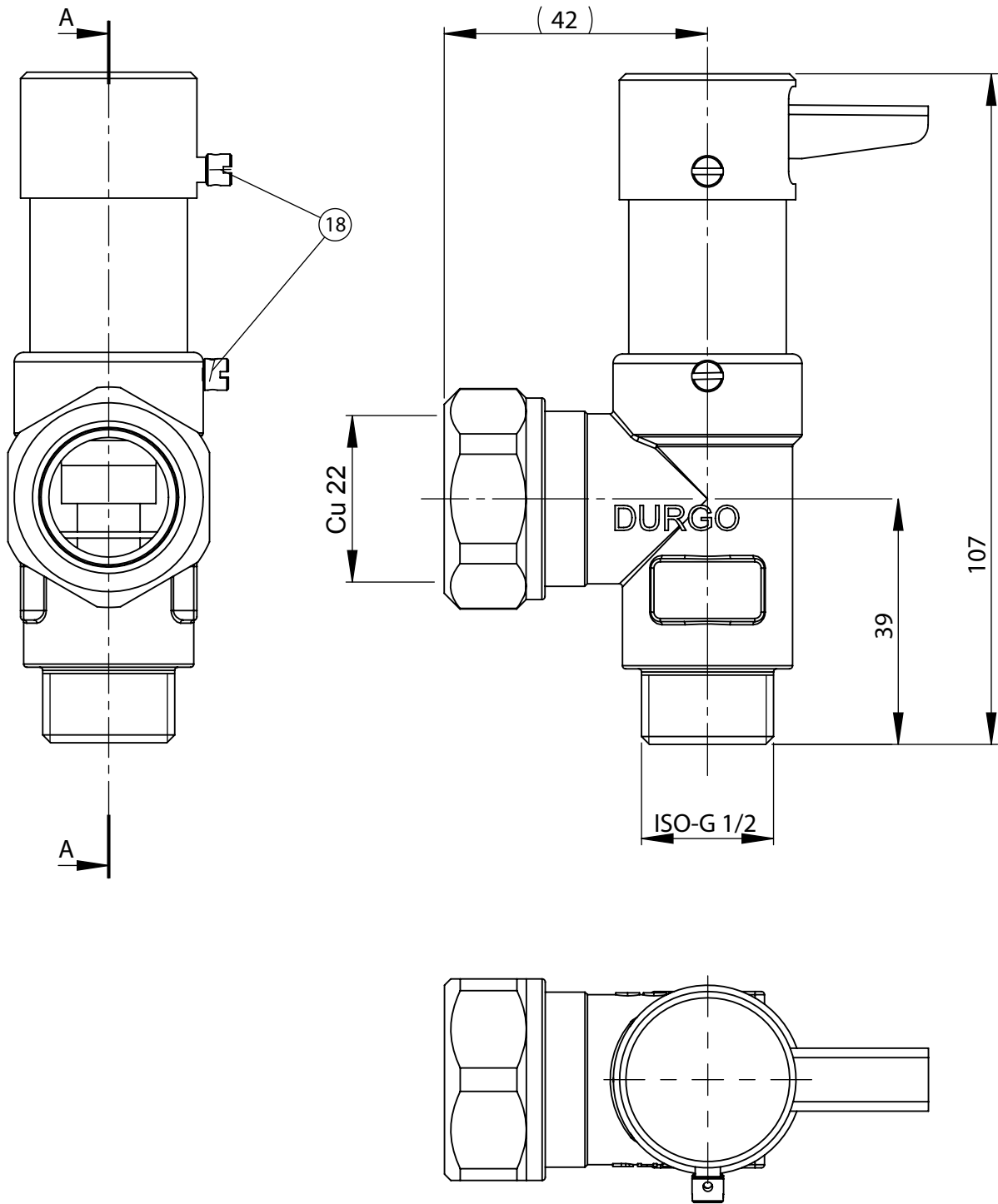

No.	Description	Date	By
1			



Säkerhetsventil		DN15/22			
Detail		Material		Blanket/Dim	
		Drawn by	Date	Scale	Weight
Box 3021, SE-169 03 SOLNA, Sweden Ph.+46 8 730 5280 Fax+46 8 735 6955 www.durgo.se sales@durgo.se		HH	2012-12-18	1:1	403 g
Säkerhetsventil GT-77		DN15/22		Dimensions SS-ISO 2768 mH	
				General tolerances Surfaces Ra 3,2	
				Drawing no. SVBA00-1-DIM r1	